

Customer Experience Center
1-800-331-4331

www.toyotaownersonline.com



moving forward ▶

FJ CRUISER



2007
Pocket Reference Guide

MN 00452-PRG07-FJC
Printed in USA 12/05

2007 FJ CRUISER

This *Pocket Reference Guide* is a summary of basic vehicle operations. It contains brief descriptions of fundamental operations so you can locate and use the vehicle's main equipment quickly and easily.

The *Pocket Reference Guide* is not intended as a substitute for the *Owner's Manual* located in the vehicle's glove box. We strongly encourage you to review the *Owner's Manual* and supplementary manuals so you will have a better understanding of the vehicle's capabilities and limitations.

Your dealership and the entire staff of Toyota Motor Sales, U.S.A., Inc. wish you many years of satisfied driving in your new FJ CRUISER.

! A word about safe vehicle operations

This *Pocket Reference Guide* is not a full description of FJ CRUISER operations. Every FJ CRUISER owner should review the *Owner's Manual* that accompanies this vehicle.

Pay special attention to the boxed "⚠️ **CAUTION**" information highlighted in this reference guide and throughout the *Owner's Manual*. Each box contains safe operating instructions to help you avoid injury or equipment malfunction.

⚠️ **CAUTION**

This utility vehicle has a significantly higher rollover rate than other types of vehicles. Refer to the *Owner's Manual* for important rollover information.

All information in this *Pocket Reference Guide* is current at the time of printing. Toyota reserves the right to make changes at any time without notice.

Spare tire & tools

Tool location

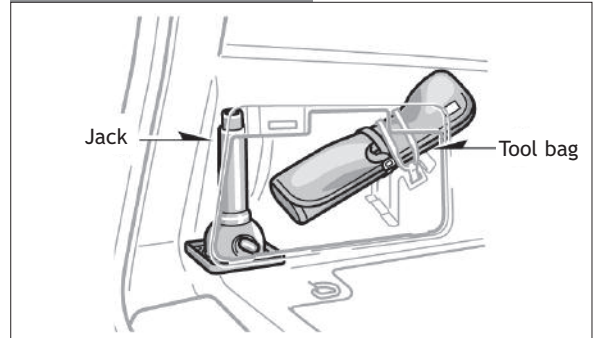

Removing the spare tire

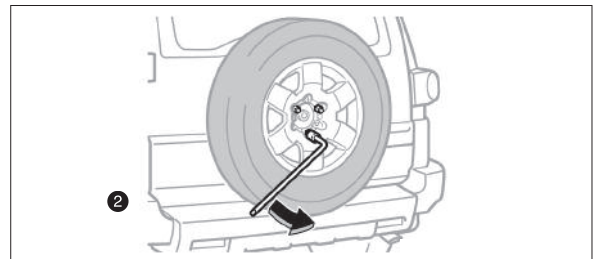
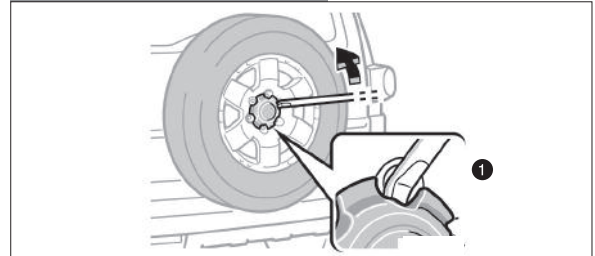

- 1 Remove the wheel ornament. (Aluminium wheel only)
- 2 Turn the hold-down nuts counterclockwise and remove.

Refer to the *Owner's Manual* for jack positioning and tire changing procedures.

INDEX

Item	Page no.
OVERVIEW	
Engine maintenance	7
Fuel tank door release and cap	6
Hood release	7
Indicator symbols	4-5
Instrument cluster	4
Instrument panel	2-3
Keyless entry¹	6
FEATURES/OPERATIONS	
Accessory meter	19
Air Conditioning/Heating	16
Audio	14-16
Auto LSD (Limited Slip Differential)	17
Automatic transmission	8
Bottle holders	18
Clock	13
Cruise control	17
Cup holders	18
Door-Back	12
Four-wheel drive	9
Intuitive parking assist	16
Light control-Instrument panel	18
Lights¹ & turn signals	13
Manual transmission	8
Parking brake	10
Power outlets	19
Seat adjustments-Front	10
Seats-Folding rear seats	11
Seats-Head restraints	10
Seats-Removing rear seats	11
Tilt steering wheel	8
Windows	12
Windshield wiper & washer	12
SAFETY AND EMERGENCY FEATURES	
Door locks	20
Seat belts	20
Seat belts-Shoulder belt anchor	20
Spare tire & tools	21

¹ Visit your Toyota dealer for information on this and other customizable options.

OVERVIEW

Instrument panel

Steering wheel controls (if equipped)

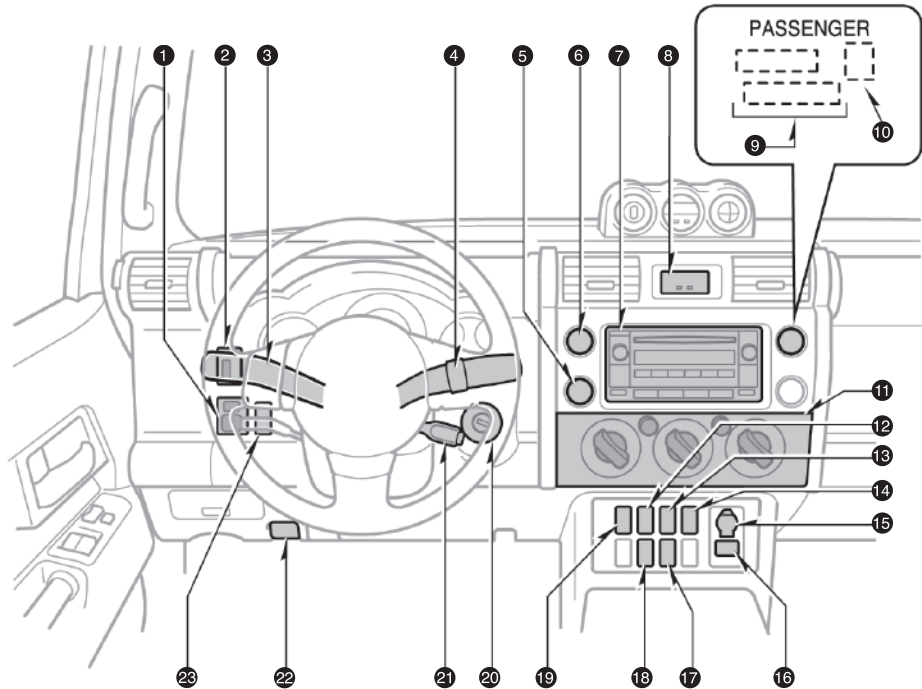
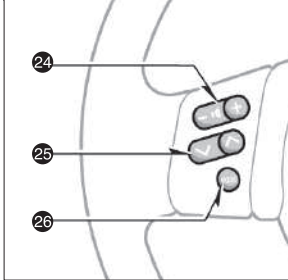





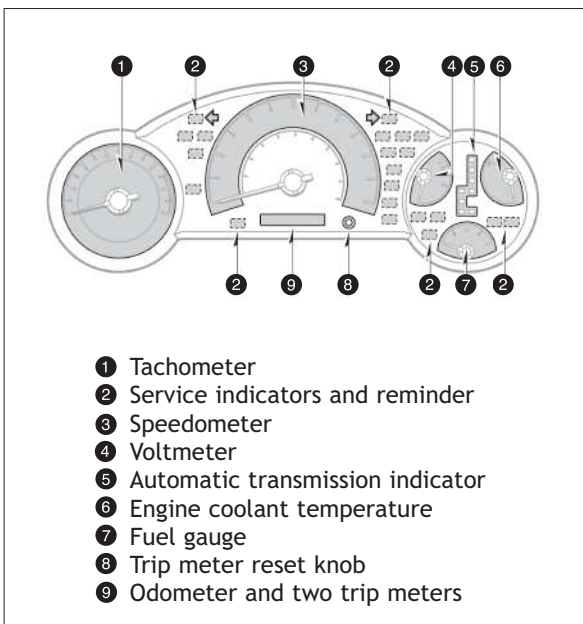



















- ① Power rearview mirror controls*
 - ② Instrument panel light control
 - ③ Headlight and turn signal control
 - ④ Wiper and washer controls
 - ⑤ Back window defogger button
 - ⑥ Emergency flasher button
 - ⑦ Audio system
 - ⑧ Clock
 - ⑨ Front passenger occupant classification indicator lights
 - ⑩ Front passenger seat belt reminder light
 - ⑪ Air Conditioning controls
 - ⑫ Rear differential lock button*
 - ⑬ Active traction control switch*
 - ⑭ Sub woofer ON-OFF button*
 - ⑮ Power outlet
 - ⑯ AUX adapter
 - ⑰ Intuitive parking assist switch*
 - ⑱ Power outlet main switch
 - ⑲ "AUTO LSD" button*
 - ⑳ Ignition
 - ㉑ Cruise control*
 - ㉒ Hood release
 - ㉓ Clutch start cancel switch*
 - ㉔ Volume control switch (for audio)*
 - ㉕ " ^ v " switch (for audio)*
 - ㉖ "MODE" switch (for audio)*
- * If equipped

Instrument cluster



Indicator symbols

-  Brake system warning¹
-  Driver's/Front passenger's seat belt reminder¹
-  Battery warning¹
-  Low engine oil pressure warning¹
-  Malfunction/Check Engine indicator¹
-  Engine oil replacement reminder¹
- 
 - Vehicle Stability Control warning¹
 - "AUTO LSD" warning¹
 - Traction Control warning¹
 - Active Traction Control warning¹
-  Open door warning¹

-  Airbag SRS warning¹
-  Automatic transmission fluid temperature warning¹
-  Transfer case is in NEUTRAL and vehicle MAY ROLL if gear shift position is in park.¹
-  Front passenger occupant classification indicator
-  Headlight high beam indicator
-  Turn signal indicator
-  Automatic transmission indicator
-  Rear differential lock indicator²
-  Center differential lock indicator³
-  Vehicle Stability Control "OFF" indicator
-  Four-wheel drive indicator³
-  Slip indicator
-  "AUTO LSD" indicator
-  Active Traction Control System indicator
-  Cruise Control indicator⁴
-  Anti-lock Brake System warning¹

CAUTION

When the Anti-lock Brake System (ABS) function is in action, you may feel the brake pedal pulsating and hear a noise. In this situation, to let the Anti-lock Brake System work for you, just hold the brake pedal down more firmly. Do not pump the brake as this will result in reduced braking performance.

¹ For details, refer to "Service reminder indicators and warning buzzers," Section 1-6, 2007 Owner's Manual.

² For details, see "Rear differential lock system," Section 1-7, 2007 Owner's Manual.

³ If this light flashes, refer to "Four-wheel drive system," Section

1-7, 2007 Owner's Manual.

⁴ If this light flashes, refer to "Cruise control," Section 1-7, 2007 Owner's Manual.

Fuel tank door release and cap

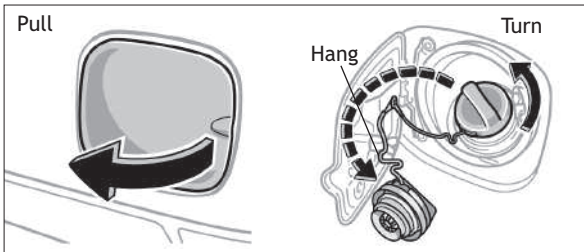

NOTE: Tighten until one click is heard. If the cap is not tightened enough, Check Engine "CHECK" indicator may illuminate.

Keyless entry (if equipped)

Beep sound can be switched "ON" or "OFF" by customer. Refer to the *Owner's Manual* for more details.

Locking operation

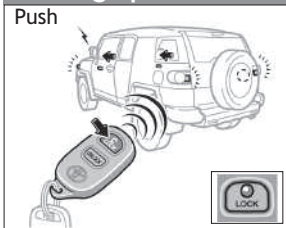

Unlocking operation



NOTE: After unlocking, if a door is not opened within sixty (60) seconds, all doors will relock for safety.

Alarm operation



Hood release

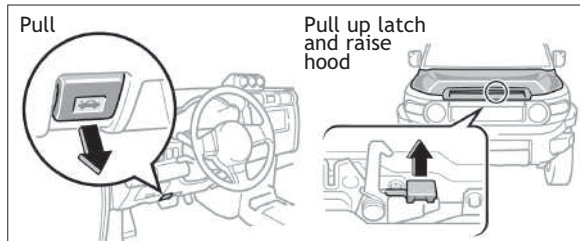

Engine maintenance

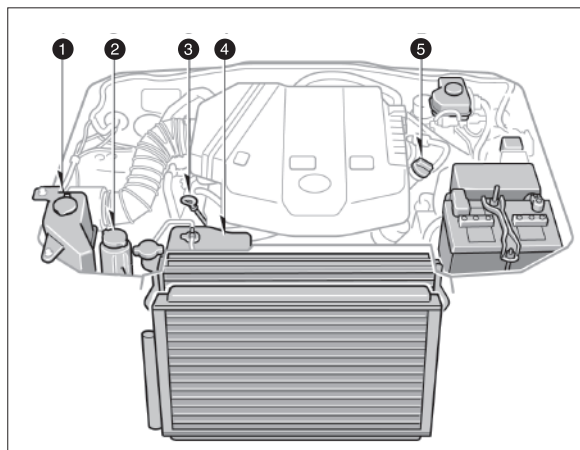

- 1 Windshield and back window washer fluid tank
- 2 Power steering fluid reservoir
- 3 Engine oil level dipstick
- 4 Engine coolant reservoir
- 5 Engine oil filler cap

Note: Regularly scheduled maintenance, including oil changes, will help extend the life of your vehicle and maintain performance. Please refer to the "Owner's Warranty Information Booklet," "Scheduled Maintenance Guide" or "Owner's Manual Supplement."

FEATURES/OPERATIONS

Automatic transmission

- P** Park¹
- R** Reverse
- N** Neutral
- D** Drive
- 4** Fourth gear
- 3** Third gear
- 2** Second gear
- L** First gear

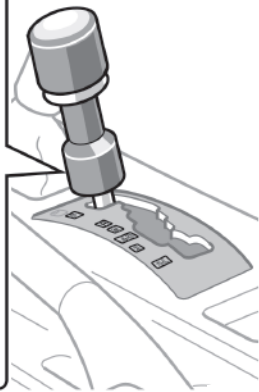

¹ The key must be in the "ON" position and the brake pedal depressed.

Downshifting increases power going uphill, or provides engine braking downhill. For best fuel economy during normal driving conditions, always drive with the shift lever in the "D" position.

Manual transmission (if equipped)

For safety, the engine will not start unless the clutch pedal is FULLY depressed.

Tilt steering wheel

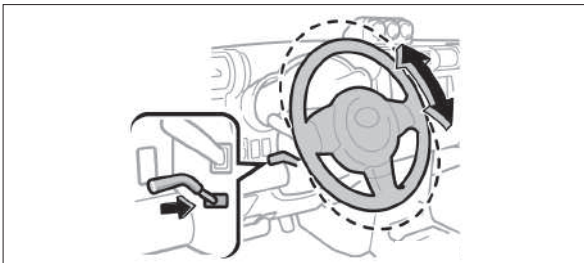

Hold the steering wheel, pull the lock release lever, tilt to the desired angle then release the lever.

Note: Do not attempt to adjust while the vehicle is in motion.

Four-wheel drive (if equipped)

Part-time four-wheel drive models

- H2** High speed (2WD)
- H4** High speed (4WD)
Shift to "H4" with speed below 50 mph.
- L4** Low speed (4WD)
Stop vehicle, shift to "N" position, then move the lever to "L4."



NOTE: For best fuel economy and performance under normal driving conditions, shift vehicle into "H2" position.

Full-time four-wheel drive models

- H** High speed
- HL** High speed
Center differential locked. Depress the clutch pedal to shift from "LL."
- LL** Low speed
Center differential locked. Stop vehicle, depress the clutch pedal to shift from "HL" with speed below 5 mph.



NOTE: For best fuel economy and performance under normal driving conditions, shift vehicle into "H" position.

Rear differential lock button



Rear differential lock/unlock

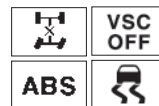

Before using the rear differential lock button:

- Shift the lever into "L4" (Part-time 4WD models)
- Shift the lever into "LL" (Full-time 4WD models)

Parking brake

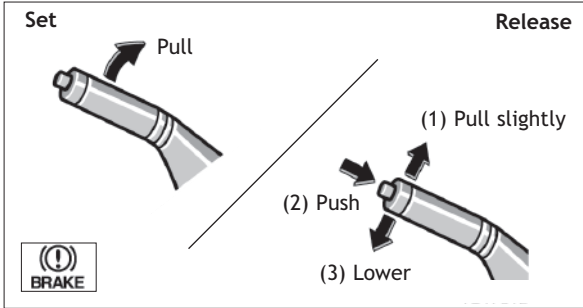

Seat adjustments-Front



- 1 Position
- 2 Cushion angle (driver side only)
- 3 Height crank (driver side only)
- 4 Seatback angle

Seats-Head restraints

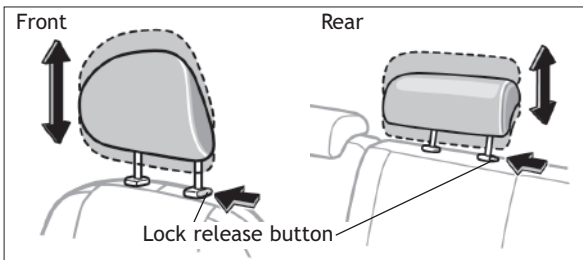

Seat-Folding rear seats

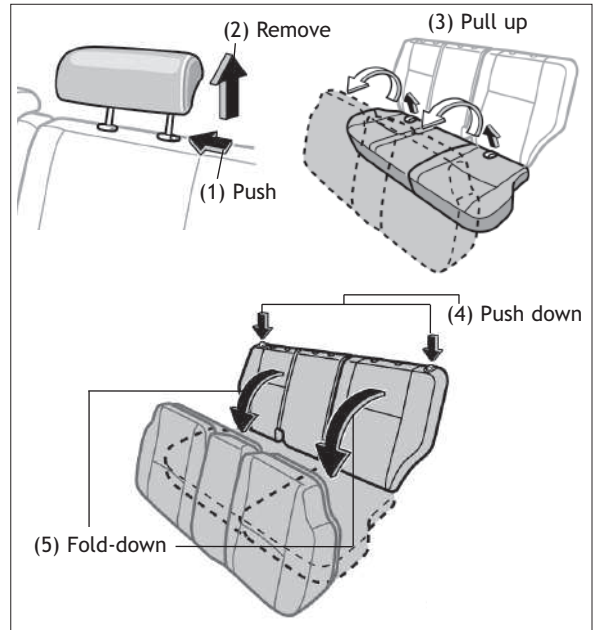

Seat-Removing rear seats

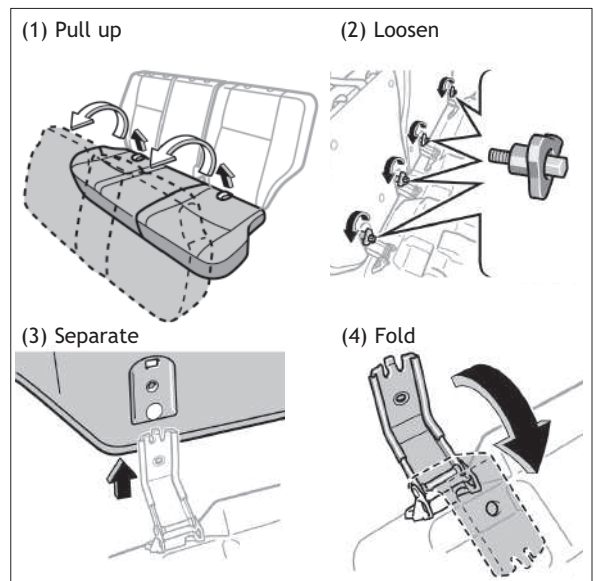

Windshield wiper & washer

Front

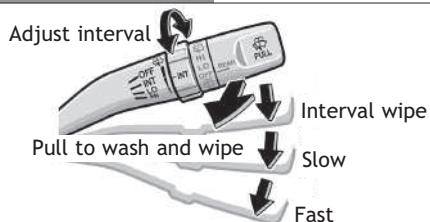

Rear

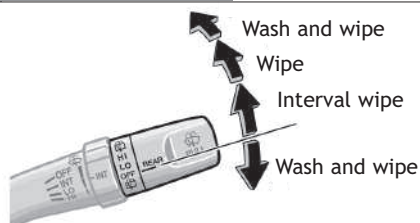

NOTE: Rear wiper and washer operate only when back window is fully closed.

Windows

Driver side

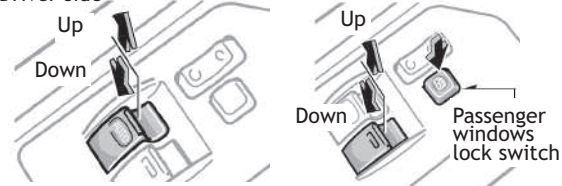

Automatic operation (Driver side only) Push the switch completely down and release to fully open. To stop window midway, lightly pull the switch up.

Door-Back

Open/Close

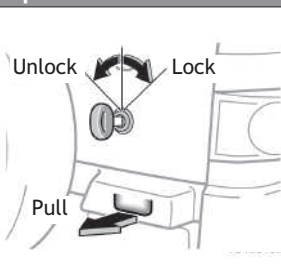

Lock in place

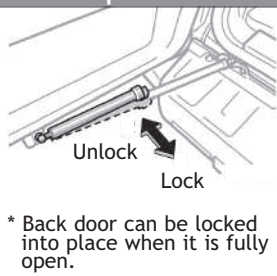

Lights & turn signals

Headlights

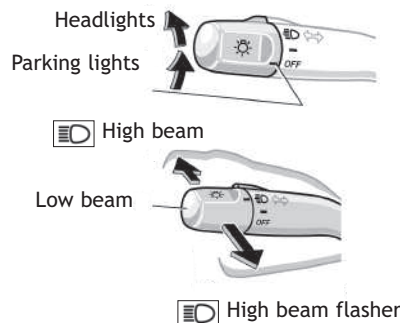

-Automatic light cutoff system Automatically turns lights off after 30 seconds when all the doors are closed with the key in "ACC" or "LOCK." Lights may also be turned off by pushing lock button on remote twice.

-Daytime Running Light system (if equipped)

Automatically turns on the headlights at a reduced intensity.

Turn signals

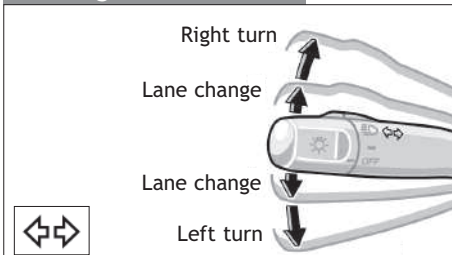

Clock

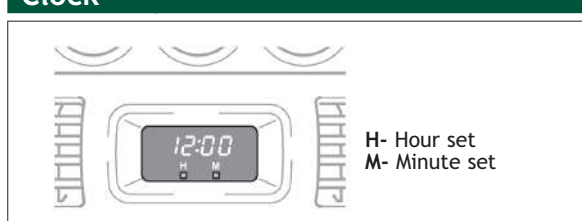

Audio

Type 1

Eject CD
 Push to turn ON/OFF
 Seek station/CD track select
 Station/CD track scan
 Mode
 View radio and CD information
 Push to skip up/down folder
 Push to adjust tone & balance
 TUNE-FILE

Preset buttons-button functions in other modes indicated above number.

Type 2

Eject CD
 Push to turn ON/OFF
 Station/CD track scan
 Seek station/CD track select
 View genre/ Push to skip up/down folder
 View radio and CD information
 Push to adjust tone & balance
 Load CD(s)

Preset buttons-button functions in other modes indicated above number.

CD PLAYER

To scan tracks on a disc Push "SCAN." Push again to hold selection.

CD Changer (Type 2)

- To load one disc Push "LOAD" and insert 1 disc.
- To load multiple discs Push and hold "LOAD" until you hear a beep. Insert one disc. Shutter will close and then re-open for next disc.
- To select a file (MP3/WMA only) Turn "TUNE-FILE" to file up/down.
- To select a folder (MP3/WMA only) Push either side of "FOLDER" or "TYPE/FOLDER."

RADIO

Preset buttons Tune in the desired station and press a preset button (1-6) until you hear a beep. Push desired preset button (1-6) to select. "SCAN" Push and hold "SCAN" to scan preset stations. Push again to hold selection.

Steering wheel switches (if equipped)

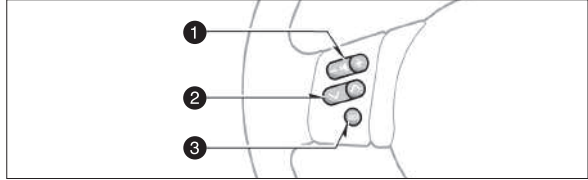

- 1 "- +"
Volume control
- 2 " ^ v "
-In radio mode Push to select a preset station, push and hold to seek the next strong station.
-In CD mode Push to skip up or down to the next or previous track.
- 3 "MODE"
Push to turn audio ON and select an audio mode. Push and hold to turn the audio "OFF."

Sub woofer switch (if equipped)

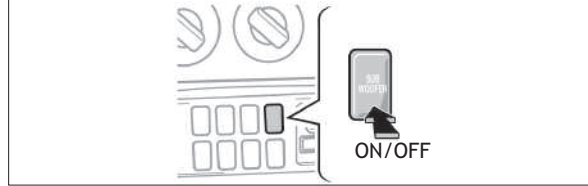

AUX adapter

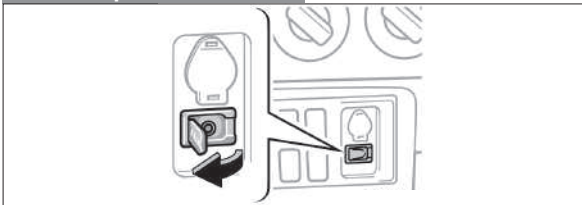

By inserting a mini plug of a commercially available component into the AUX adapter, you can listen to music from a portable audio device through the vehicle's speaker system.

Air Conditioning/Heating

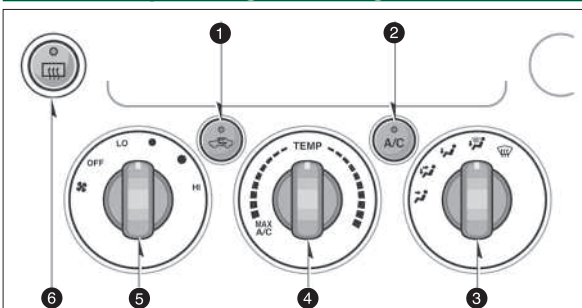

- 1 Fresh or recirculate cabin air
- 2 Air Conditioning ON/OFF
- 3 Air flow vent selector

In “” or “” mode, use fresh air (“” indicator OFF) to reduce window fogging.

- 4 Temperature
- 5 Fan speed
- 6 Rear defogger

Intuitive parking assist (if equipped)

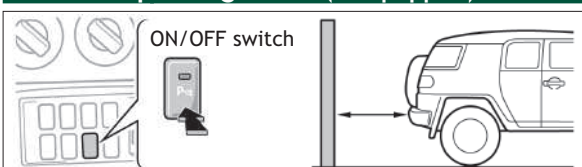

When vehicle is in reverse, a buzzer will sound to inform driver when nearing an obstacle. The system can only be used when the transmission is in the “R” position.

Cruise control

Turning system ON/OFF

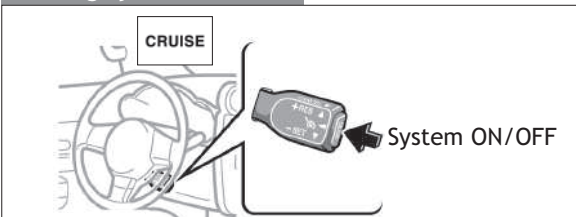

Functions

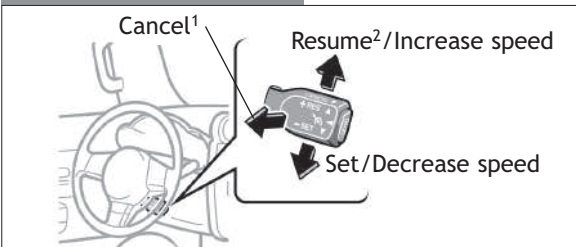

¹ The set speed may also be cancelled by depressing the brake pedal.

² Unless vehicle speed drops below 10 mph, the set speed may be resumed once vehicle exceeds 25 mph.

Auto LSD (Limited Slip Differential) (if equipped)



Push the “AUTO LSD” switch when the vehicle is stopped. To deactivate, push the switch again. **NOTE:** This system should ONLY be used when wheel spinning occurs on slippery or unpaved surfaces.

Refer to the *Owner's Manual* for complete details on this system before attempting to use it.

Light control-Instrument panel

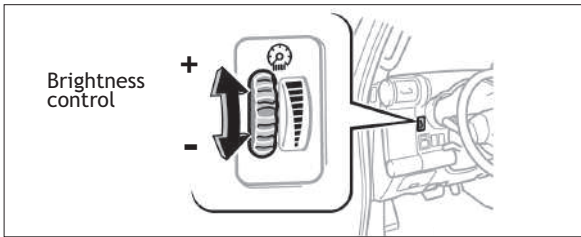

Bottle holders-rear seat

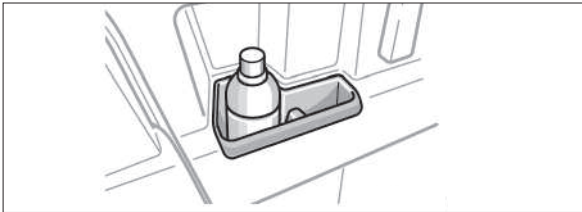

Cup holders

Automatic transmission models

Detachable adaptor

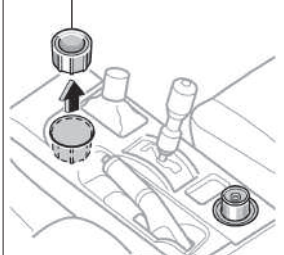

Manual transmission models

Detachable adaptor

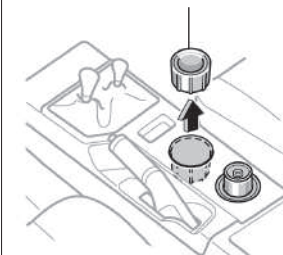

Rear console

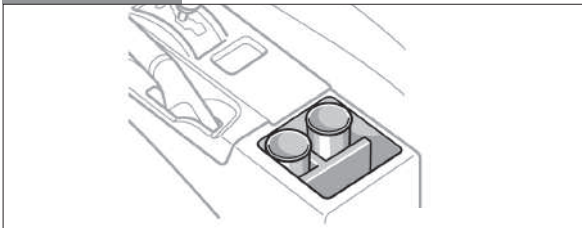

Power outlets

12V DC

Instrument panel

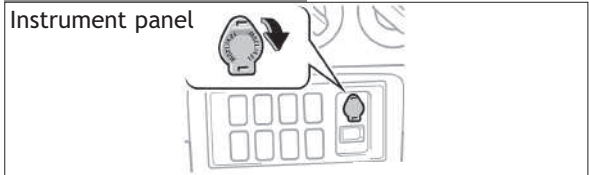

115V AC (if equipped)

ON/OFF switch

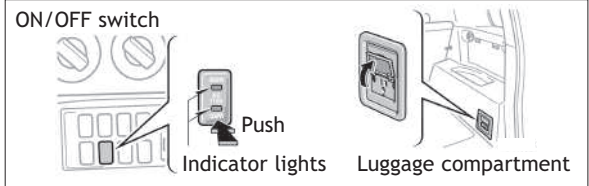

The illumination changes according to the maximum available capacity.

- Green and Yellow 115V AC/400W
- Yellow 115V AC/100W

Accessory meter (if equipped)

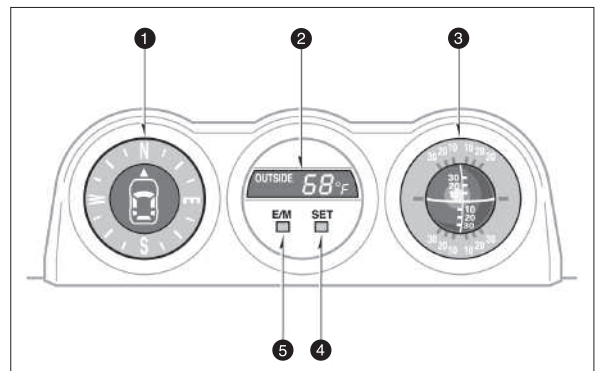

- 1 Compass
- 2 Outside temperature display
- 3 Clinometer-vehicle slant
- 4 Calibrating the compass setting
- 5 Switching Fahrenheit and centigrade of thermometer

SAFETY AND EMERGENCY FEATURES

Seat belts

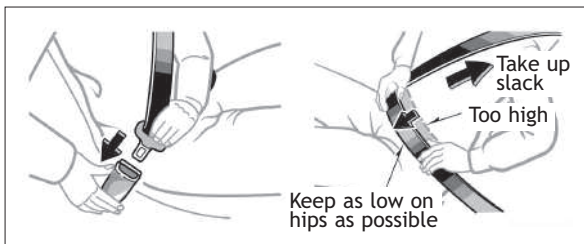

If belt is fully extended, then retracted even slightly, it cannot be re-extended beyond that point, unless fully retracted again. This feature is used to help hold child restraint systems securely.

To find more information about seat belts, and how to install a child restraint system, refer to the *Owner's Manual*.

Seat belts-Shoulder belt anchor

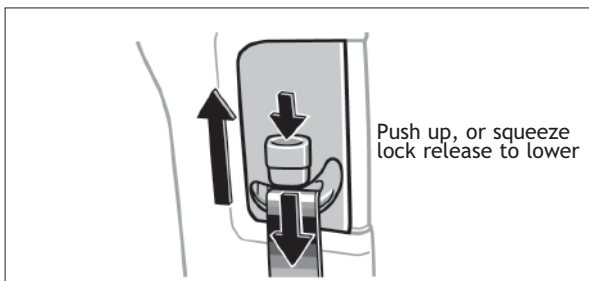

Door locks

